



Methods

Evaluation of centrifugal methods for measuring xylem cavitation in conifers, diffuse- and ring-porous angiosperms

Yangyang Li¹, John S. Sperry², Haruhiko Taneda^{3,2}, Susan E. Bush² and Uwe G. Hacke⁴

¹State Key Laboratory of Soil Erosion and Dryland Farming, Institute of Soil and Water Conservation, CAS & MWR, Yangling Shaanxi, China; ²Department of Biology, University of Utah, 257S 1400E, Salt Lake City, UT 84112, USA; ³Department of Biological Sciences, Graduate School of Science, University of Tokyo, Tokyo, Japan 113-0033; ⁴Department of Renewable Resources, University of Alberta Edmonton, AB T6G 2H1, Canada

Summary

Author for correspondence:

John Sperry

Tel: +801 5850379

Fax: +801 5814668

Email: j.sperry@utah.edu

Received: 18 July 2007

Accepted: 31 August 2007

- A centrifugal method is used to measure 'vulnerability curves' which show the loss of hydraulic conductivity in xylem by cavitation. Until recently, conductivity was measured between bouts of centrifugation using a gravity-induced head. Now, conductivity can be measured during centrifugation. This 'spin' method is faster than the 'gravity' technique, but correspondence between the two has not been evaluated.
- The two methods were compared on the same stem segments for two conifer, four diffuse-porous, and four ring-porous species.
- Only 17 of 60 conductivity measurements differed, with differences in the order of 10%. When different, the spin method gave higher conductivities at the beginning of the curve and lower at the end. Pressure at 50% loss of conductivity, and mean cavitation pressure, were the same in 14 of 20 comparisons. When different, the spin method averaged 0.32 MPa less negative. Ring-porous species showed a precipitous initial drop in conductivity by both techniques. This striking pattern was confirmed by the air-injection method and native embolism measurements.
- Close correspondence inspires confidence in both methods, each of which has unique advantages. The observation that ring-porous species operate at only a fraction of their potential conductivity at midday demands further study.

Key words: functional wood anatomy, plant vascular physiology, plant water transport, vulnerability curves, water stress, xylem cavitation.

New Phytologist (2008) **177**: 558–568

© The Authors (2007). Journal compilation © *New Phytologist* (2007)

doi: 10.1111/j.1469-8137.2007.02272.x

Introduction

Water transport through the xylem is essential for replacing water loss during transpiration, thereby preventing desiccation and maintaining photosynthesis. During the transport process, the increasingly negative pressures in the liquid water inside the xylem conduits can lead to cavitation. Cavitation is the abrupt transition from metastable liquid to

gas (Zimmermann, 1983). The subsequent expansion of the gas phase fills the conduit, creating an embolus that impairs water transport. One of the more useful ways to quantify a plant's cavitation response is to generate a 'vulnerability curve' – the relationship between the hydraulic conductivity of xylem and the xylem pressure (Tyree & Sperry, 1989). From these curves, the mean cavitation pressure can be calculated as well as the pressure causing 50% loss of hydraulic

Fig. 1 Rotor design used for the spin and gravity methods. The stem segment is held at its center by a thin steel plate (g). Stem ends are immersed during spinning in an upstream (d) and downstream (e) Plexiglas reservoir with a maximum level during spinning (dashed meniscus) determined by the drain hole in the side ('drain' arrows). This level was 5 mm higher (closer to center of rotation) in the upstream reservoir, driving water through the stem (stem arrows). Reservoirs were filled during spinning by injecting solution into the central port (c) where it was forced through the tubing (c to d and e). The fall of the meniscus was observed in a monocular microscope mounted over holes in the rotor lid (b), illuminated by a fiber optic source (a) whose light was bent by a mirror (f) to holes drilled in the sides of the rotor. The rotor fits a Sorvall RC-5C or RC-5B centrifuge (Thermo Fisher Scientific, Waltham, MA, USA).

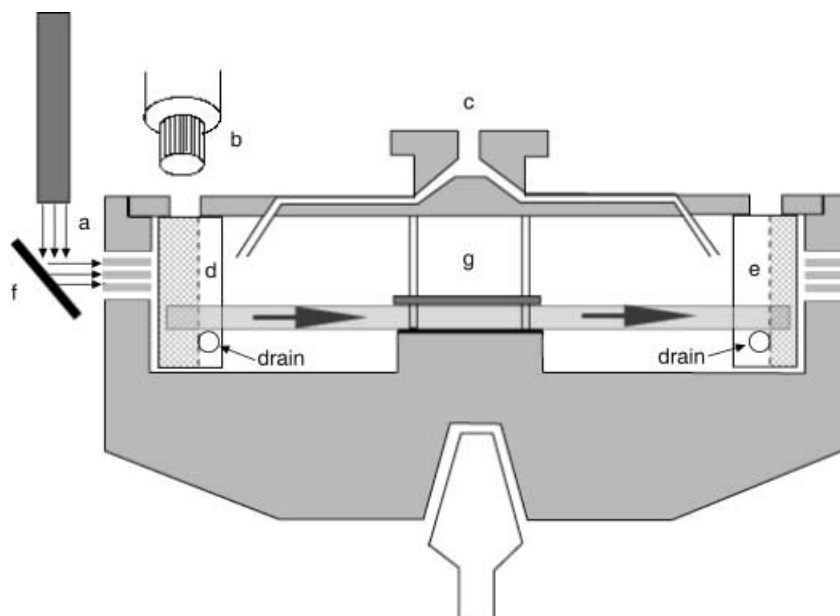

conductivity (P_{50}). Vulnerability curves also allow one to predict the sensitivity of stomatal closure and plant water use to drought (Sperry *et al.*, 1998).

Vulnerability curves are often measured with a centrifugal force technique (Pockman *et al.*, 1995; Alder *et al.*, 1997; Cochard, 2002; Cochard *et al.*, 2005). Negative pressure and cavitation are induced in xylem segments by spinning them in a custom-built centrifuge rotor. Centrifugal techniques allow the entire curve to be measured relatively quickly on a single xylem segment, and the segment can be treated ahead of time to remove any native embolism. These are important advantages over the original dehydration method (Sperry, 1986) where branch systems are dried to different negative pressures and the curve assembled from conductivity measurements made on multiple segments.

In the traditional centrifugal method, segments must be removed from the rotor for the conductivity measurement between intervals of spinning (Pockman *et al.*, 1995; Alder *et al.*, 1997). This is referred to as the 'gravity' method because a hydraulic head is used to drive water through the segment during the conductivity determination. Since its development in 1995 it has seen wide application (Pockman & Sperry, 2000; Hacke *et al.*, 2001a, 2006; Davis *et al.*, 2002; Maherali *et al.*, 2003; McElrone *et al.*, 2004; Pittermann *et al.*, 2006; Willson & Jackson, 2006).

Recently, Cochard and colleagues have introduced a variation where the conductivity of the segment is measured while it is spinning and under negative pressure (Cochard, 2002; Cochard *et al.*, 2005). In this 'spin' method, the stem ends are immersed in water during spinning as they are in the gravity method, but the water level in the upstream reservoir (Fig. 1d) is 'higher' than in the downstream one, which is held at a constant position (Fig. 1e). Higher in this context means the

water level is closer to the center of rotation in the upstream reservoir (Fig. 1, compare water levels in reservoirs). The rotational force drives the water through the segment (Fig. 1, arrows) until the upstream reservoir falls to the downstream level. The flow is measured by observing the fall in the meniscus in the upstream reservoir as it rushes past in a blur beneath a microscope (Fig. 1b). The spin method is even faster than the gravity technique at giving a curve (usually < 30 min). This makes it ideal for ecological and genetic studies which require large sample sizes.

Cochard *et al.* (2005) compared his new spinning technique against the dehydration method in several conifers, diffuse-, and ring-porous angiosperms. Although there was generally good agreement, most of the comparisons were based on different sources of plant material sampled at different times. Furthermore, the spin technique was judged not to work for the ring-porous species. It was speculated that this was because many of the long vessels in this species were cut open at both ends in the 28 cm stem segments used.

To date there has been no comparison of the new spin method with the standard gravity technique in general use. There are several differences between the two versions that could give different results. The spin method has the virtue of measuring the conductivity while the xylem is under negative pressure as it is in the intact plant. This prevents any refilling of cavitared xylem during the conductivity measurement. In the gravity method, the stems are taken out of the centrifuge and the hydraulic conductivity measurement is made under slight positive pressure. There is the potential for xylem refilling (Canny, 1998) and vessel diameter may increase because of the higher internal fluid pressure. The methods also differ in the magnitude of the pressure difference driving the flow. In the spin method it tends to be much greater

(c. 10–200 kPa, depending on angular velocity and reservoir level) than in the gravity method (3–7 kPa). Consequent differences in flow velocity could alter pit membrane configuration or other aspects of the flow path and change hydraulic conductivity. Finally, while both methods have the ends of the stem immersed in water during rotation, there is little or no flow through the segment as cavitation is being induced in the gravity method whereas this flow is substantial in the spin method. If the flow of test solution through the low pressure zone in the stem center influences cavitation it could alter the vulnerability curve. For example, flow could introduce artificial nucleating agents into the stem, or it could sweep developing gas voids out of the negative pressure region (Cochard *et al.*, 2005). All of these differences between the methods make it important to compare them.

In this paper, the 'spin' variation of the centrifugal method is compared against the original 'gravity' method by using both to measure vulnerability curves and hydraulic conductivity on the same stem segments. This head-to-head comparison was done for multiple conifer, diffuse-porous angiosperm, and ring-porous angiosperm species. For the problematic ring-porous species (and some diffuse-porous ones) we also compared the spin method with the air-injection technique and with the native embolism caused by physiological xylem pressure in the intact tree. The air injection method is based on the observation that the pressure required to push air into the functional xylem and decrease its conductivity is approximately equal and opposite to the negative pressure causing cavitation (Sperry & Tyree, 1990; Cochard *et al.*, 1992; Salleo *et al.*, 1992; Sperry & Saliendra, 1994). This supports the theory that cavitation is nucleated by air sucked through the conduit wall by negative pressure (Zimmermann, 1983; Sperry *et al.*, 1996).

Materials and Methods

Plant material

The method comparison was performed on 10 species including: two coniferous species (*Abies concolor* (Gordon & Glendinning) Lindley ex Hildebrand, *Chamaecyparis lawsoniana* (A. Murr.) Parl.), four diffuse-porous species (*Betula occidentalis* Hook., *Acer negundo* L., *Populus fremontii* S. Wats. and *Tilia cordata* P. Mill.) and four ring-porous species (*Quercus gambelii* Nutt., *Albizia julibrissin* Durazz., *Morus alba* L. and *Fraxinus pensylvanica* Marsh.) during the period from April to October in 2006. All samples were collected on the campus of University of Utah (Salt Lake City, UT, USA) except *P. fremontii* and *Q. gambelii*. *Populus fremontii* stems were harvested along the Jordan River in the Salt Lake Valley and *Q. gambelii* stems were harvested from the natural stands in Red Butte Canyon c. 15 km east of the University of Utah. Stems, 1–4 yr old, were cut from the plant and wrapped immediately in plastic bags to prevent

dehydration and brought back to the laboratory. In the laboratory, 280-mm long segments were excised while any leaves and lateral twigs present were removed under tap water. Sample ends were trimmed with a fresh razor blade until the stem length was c. 275 mm as required to fit the centrifuge rotor. The bark was peeled from both ends for c. 10 mm. The prepared stem segments were put in water until ready for use.

Comparison of spin and standard gravity methods

1. Initial branch area-specific conductivity (K_i) Xylem segments of angiosperm species were flushed with filtered (0.2 μm) 20 mM KCl solution for 30 min at c. 100 kPa to remove air emboli formed *in vivo* (native embolism) or caused during harvest. Conifer segments were not flushed because native embolism during the growing season is usually minimal in the absence of significant water stress (Sperry *et al.*, 1994). The initial conductivity (K_i) of the segment was measured by the gravity method. The hydraulic head pushing the KCl solution through the stem was typically c. 4–6 kPa in diffuse-porous or conifer stems and 2–3 kPa in ring-porous stems. The smaller head for ring-porous species was used to avoid displacing air from conduits that were cut open at both ends when they became embolized during the course of the vulnerability curve. Conductivity was calculated as the quotient of the mass flow rate of solution through the segment and pressure gradient along the segment. It was expressed on a branch cross-sectional basis, where cross sectional area was calculated from stem diameter (not including bark) averaged between both ends.

2. Spin method The stem segment was installed in a custom-built centrifuge rotor (Fig. 1) designed by J. S. Sperry (plans available on request) for a Sorvall RC-5C or RC-5B centrifuge (Thermo Fisher Scientific, Waltham, MA, USA). The rotor was originally built for the standard method where the stem is removed for the conductivity measurement. It was built for 275 mm xylem segments, a length similar to what Cochard *et al.* (2005) used. A few modifications drawn from the Cochard rotor design allowed the conductivity to be measured during spinning. These included holes drilled in the side of the rotor to illuminate the meniscus in the Plexiglas reservoirs (Fig. 1a) and holes drilled through the lid above the reservoirs so that the meniscus could be viewed with a monocular microscope (Fig. 1b) inserted through a hole drilled in the plywood lid of the Sorvall centrifuge. A groove was cut in the rotor lid to rout tubing from a port at the center of rotation on the lid to the reservoirs at each end of the stem segment (Fig. 1c,d,e). The stem was held firmly inside the rotor by a thin steel plate tightened down by nuts on the bolts that also hold down the rotor lid (Fig. 1g). This arrangement accommodates stems of varying shapes and thicknesses and leaves the ends of the stems free inside reservoirs. This differs from the Cochard rotor where the stem is not held at the

center, but lies in a groove and rests on the heavy basal end when it spins. This end can be beveled to minimize any blockage of water flow.

With the stem and rotor lid secured, the centrifuge door was closed and the microscope and lighting adjusted. The monocular was mounted on a boom stand on an adjacent table. A fiber light was inserted through a tube mounted in another hole cut in the centrifuge door. A 45° mirror redirected the light through the holes in the side of the rotor (Fig. 1f). The speed of the centrifuge was set to give the first target pressure for the vulnerability curve. As soon as the rotor started spinning, filtered 20 mM KCl solution was injected through plastic tubing into the central port of the lid. The plastic tubing was guided through copper tubing secured through a third hole drilled in the centrifuge door (not shown). The reservoirs were filled to the maximum level set by small holes drilled in the side (Fig. 1, drain holes in reservoirs d and e). The 5 mm higher level in the upstream reservoir (d) generated the pressure difference driving water through the segment to the downstream side (e) where it bled out through the side-hole. Once the centrifuge reached its target speed, the standard procedure was to let it spin for 3 min before measuring the conductivity. Preliminary measurements with a number of species indicated that any drop in conductivity by cavitation was complete well before the 3-min mark.

Through the microscope, two menisci were visible: the stationary meniscus of the downstream reservoir and the moving meniscus of the upstream one. The rate at which the upstream meniscus fell was measured with an eyepiece reticule and stop watch. The reticule was calibrated to give the actual distance traveled per unit time. This was multiplied by the surface area (s) of the water in the upstream reservoir and the density of water to yield the mass flow rate of water through the stem; s was obtained by measuring the diameter of the essentially circular upstream stem end, and subtracting its cross-sectional area from the total water surface in the reservoir. To ensure a reasonable traveling rate for the meniscus regardless of the stem's initial conductivity, three pairs of reservoirs were used with small (317 mm²), medium (850 mm²) and large (955 mm²) surface areas. The larger the surface area, the slower the rate of travel for a given conductivity. The upstream reservoir was refilled as many times as needed to get a set of at least five flow rate measurements.

The actual water pressure at the center of the stem was calculated as $-0.25\rho\omega^2[R_m^2 + R^2]$, where ρ is the density of water, ω is the angular velocity, R_m is the distance from the center of rotation to the surface of the stationary downstream meniscus and R is the distance from the center of rotation to the moving upstream meniscus (Cochard *et al.*, 2005). We used the maximum R during the measurement series to calculate the stem pressure because this corresponded to the most negative pressure the stem was exposed to during the series.

The pressure gradient driving the flow was given by: $0.5\rho\omega^2[R_m^2 - R^2]/L$, where L was the stem length (Cochard *et al.*, 2005). Because R increases during the flow rate measurement, the pressure gradient decreases nonlinearly. The most accurate conductivity calculation over a discrete time interval Δt must integrate the flow rate per pressure gradient as R moves from R_1 to R_2 . This gives: $K = sL/(\Delta t R_m \omega^2) \ln[(R_m + R_2)(R_m - R_1)(R_m + R_1)^{-1}(R_m - R_2)^{-1}]$. In practice, this calculation typically is within 1% of the conductivity estimated by Cochard *et al.* (2005) where the flow rate was divided by a pressure gradient calculated from the mid-point R -value ($(R_1 + R_2)/2$). Conductivities for each of the five or more successive time intervals were averaged to obtain the mean for that stem pressure. All conductivities were expressed on a branch cross-sectional area basis as described for the initial conductivity measurement.

The total time spent at the target pressure was usually 5–8 min. During this time, the temperature-controlled centrifuge maintained the chamber within a few degrees of room temperature (*c.* 24°C). The KCl solution that was injected at frequent intervals into the spinning rotor reservoirs was also at room temperature, as was the solution used for the gravity measurement. For these reasons, the spin and gravity measurements were assumed to have been made at the same temperature.

Occasionally, the meniscus was difficult to see when the stem was spinning at very high speeds or when it was extensively cavitated. In these cases, the conductivity at a less negative pressure was measured after a minimum of 3 min of exposure at the target pressure. This allowed better resolution of the meniscus. Like Cochard (2002), we observed no difference in conductivity measured in a stem at the target pressure vs the conductivity measured later at a less negative pressure.

3. Gravity method The centrifuge was stopped after the spinning conductivity measurement was completed. The stem was removed from the centrifuge and its conductivity measured by the same gravity method used to obtain the initial conductivity in step 1.

4. Completion of vulnerability curves Steps 2 and 3 were repeated with the same stem exposed to successively more negative pressures in the centrifuge. This was continued until at least 85% of the initial conductivity was lost. In this way we obtained two vulnerability curves for one stem – one curve based on the gravity measurements, and the other based on the spinning measurements. The comparison was conducted on at least six stems for each species.

Vulnerability curves were evaluated in two formats: as actual branch-area specific conductivities decreasing with more negative xylem pressure, and as the percentage loss in conductivity (PLC – relative to the initial K_i measurement) increasing with negative xylem pressure. The first format

allowed direct comparison of the conductivities from the same stems by both methods. The PLC format was used only when comparing spin method results with the air injection method where separate stems with potentially different initial conductivities had to be used. In both the spin and air-injection method the PLC was calculated relative to the initial K_i measurement made after flushing and before any embolism induction.

Air injection method

Vulnerability curves of all ring-porous species (excluding *A. julibrissin*) and two diffuse-porous species (*P. fremontii* and *T. cordata*) were also determined by the air-injection method (Sperry & Saliendra, 1994). For *A. julibrissin*, the air injection method was only used to measure embolism at a single pressure (−0.2 MPa). A separate set of stem segments was prepared from the same trees sampled for the centrifuge methods. The stems were of the same length (275 mm) and were flushed as described above to remove native embolism. Stems were inserted through a double-ended pressure bomb. Tubing filled with 20 mM KCl solution was attached to the proximal end. The distal end was open to air. Flow through the segment was induced by a hydraulic head as in the gravity method. Mass flow rate of solution was measured by collecting effluent from the distal end with tared vials filled with absorbent paper over 1-min intervals. The air pressure in the chamber was reduced to atmospheric during conductivity measurements. Hydraulic conductivity measurements were alternated with 10 min exposure of the segment inside the chamber to progressively higher air pressures. Measurements were continued until hydraulic conductivity had decreased by > 90% from its initial value because of air entering intact xylem conduits. The air injection method was performed on six stems per species.

Native embolism

Native embolism in stems of the ring-porous trees *Q. gambelii* and *F. pensylvanica* was measured by harvesting branches in the field, cutting segments from them in the laboratory under water, and measuring the conductivity by the gravity method before and after flushing the stems to remove reversible embolism. Stems were of similar age and size, and from the same plants as the stems used for the vulnerability curves. Harvested branches were long enough so that vessels embolized by the initial cut did not penetrate into the conductivity segment. *In situ* stem xylem pressure before branch harvest was estimated from pressure chamber measurements on leaves or small side-branches that had been sealed with reflective aluminum tape the evening before to prevent transpiration and to promote equilibration with the parent axis. Five stems of each species were measured to evaluate native embolism.

Statistics and vulnerability curve analysis

The SPSS 11.0 statistics software package (SPSS, Chicago, IL, USA) was used to analyse the data at 0.05 significance level. The analysis focused on two pair-wise comparisons: spin vs gravity and spin vs air-injection. To compare spin and gravity variants of the centrifuge technique (mean conductivity, PLC, Weibull function parameters, mean cavitation pressure and P_{50}) we used paired *t*-tests because the same set of stems was compared. To compare the spin method and the air-injection technique parameters were tested with independent sample '*t*-tests' because separate stems were compared. The use of separate stems with possibly different initial conductivities in the air-injection curves prevented a direct comparison of conductivities.

The Weibull function gives conductivity as: $K_{\max} e^{-(x/b)^c}$, where K_{\max} represents the conductivity in the absence of any embolism, x is the xylem pressure, and b and c are curve fitting parameters. Parameter b is the absolute value of the xylem pressure for K equal to $K_{\max} e^{-1}$ ($K \approx 36.8\%$ of K_{\max}), and c represents the steepness of the curve slope at b with higher values representing steeper slopes. We used the Weibull function because it is a relatively simple function that fits a wide variety of curve shapes equally well (Neufeld *et al.*, 1992). We used standard curve-fitting software to obtain the K_{\max} , b and c for each stem and method. Although we measured K_{\max} with the gravity method ($K_{\max} = K_i$), it is impossible to measure with the spin method because the measurement requires negative pressure and the potential for embolism formation. Thus, to compare Weibull curves between methods, we did not constrain K_{\max} for the curve fit. The Weibull fit was used to calculate the xylem pressure at 50% loss of conductivity (P_{50}), and the mean cavitation pressure for each stem and method. The mean cavitation pressure was calculated as the product of xylem pressure and incremental loss in conductivity (over 0.01 MPa intervals), summed across all pressures and divided by the total conductivity. For a normal distribution of conductivity loss increment with pressure, the P_{50} = the mean cavitation pressure. Both parameters are widely used for comparing vulnerability curves (Linton *et al.*, 1998; Hacke *et al.*, 2006).

Results

Conifer species

Vulnerability curves by the spin or gravity method in both conifers were similar (e.g. Fig. 2. *A. concolor*). Only three of 13 conductivity measurements differed for the two conifer species, and then the absolute value of the deviation averaged only 12% relative to the species' initial conductivity (Fig. 3). In *C. lawsoniana* the Weibull function used to fit vulnerability curves did not differ in its b and c parameters between methods (Table 1); neither did the average P_{50} or mean

Table 1 Weibull function parameters for vulnerability curves by the spin, gravity and air-injection methods

Species	Spin method		Gravity method		Air injection	
	b ± SE (MPa)	c ± SE	b ± SE (MPa)	c ± SE	b ± SE (MPa)	c ± SE
<i>Abies concolor</i>	3.62 ± 0.09	6.08 ± 1.01	3.97 ± 0.13*	5.95 ± 0.61		
<i>Chamaecyparis lawsoniana</i>	7.76 ± 0.18	2.89 ± 0.14	8.00 ± 0.38	3.69 ± 0.45		
<i>Betula occidentalis</i>	1.49 ± 0.05	8.22 ± 0.81	1.51 ± 0.05	5.88 ± 0.65*		
<i>Acer negundo</i>	0.81 ± 0.32	1.02 ± 0.31	1.42 ± 0.15*	1.06 ± 0.25		
<i>Populus fremontii</i>	1.70 ± 0.17	4.92 ± 1.09	1.55 ± 0.25	2.17 ± 0.55	1.41 ± 0.21	1.88 ± 0.27*
<i>Tilia cordata</i>	2.69 ± 0.02	6.04 ± 0.74	2.76 ± 0.06	4.50 ± 0.65	2.80 ± 0.47	3.19 ± 0.28*
<i>Quercus gambelii</i>	0.17 ± 0.11	0.97 ± 0.28	0.25 ± 0.10	0.76 ± 0.22	0.98 ± 0.45	0.84 ± 0.13
<i>Albizia julibrissin</i>	0.04 ± 0.04	0.75 ± 0.34	0.14 ± 0.02*	0.84 ± 0.17		
<i>Morus alba</i>	0.46 ± 0.08	0.94 ± 0.18	0.21 ± 0.04	0.17 ± 0.03*	0.63 ± 0.12	0.83 ± 0.10
<i>Fraxinus pensylvanica</i>	0.19 ± 0.05	2.37 ± 0.49	0.15 ± 0.03	1.25 ± 0.05	0.12 ± 0.02	0.97 ± 0.18*

The b parameter is the absolute value of the xylem pressure at 36.8% of initial conductivity, the c parameter is related to the slope at that point (larger is steeper). Asterisks show significant difference for spin method when compared with either the gravity or air-injection standards.

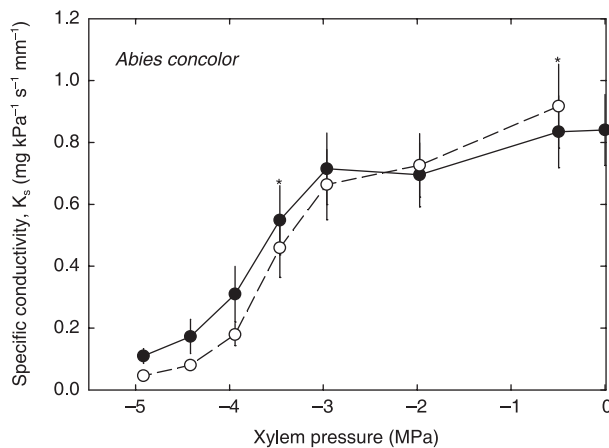

Fig. 2 Vulnerability curves for the conifer *Abies concolor* using the spinning (open circles) and gravity (closed circles) methods on the same stem segments. Asterisked points differ by paired sample *t*-test. Mean ± SE for six stems.

cavitation pressure (Fig. 4 ‘Cl’). In *A. concolor*, the spin method yielded a 0.35 MPa lower Weibull b-value (Table 1) than the gravity method. This gave a P_{50} and mean cavitation pressure that was *c.* 0.33 MPa, or 9%, less negative than the gravity method (Fig. 4 ‘Ac’).

Diffuse-porous species

In general, the spin and gravity methods also gave similar vulnerability curves for the four diffuse-porous species (e.g. Fig. 5, *P. fremontii*). Only nine of 24 conductivity measurements differed, and the absolute value of these deviations averaged only 8% relative to the species’ initial conductivity (Fig. 6a). In *T. cordata* and *P. fremontii*, the Weibull curves by the two methods were not different; neither were the P_{50} values nor mean cavitation pressures (Fig. 4, closed symbols, Tc, Pf). In *B. occidentalis*, the Weibull slope

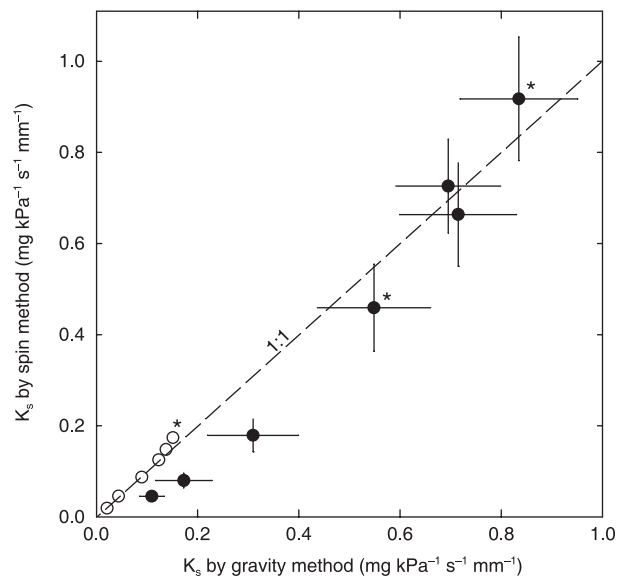

Fig. 3 Hydraulic conductivity on a stem cross sectional basis measured by the spin and gravity methods on the same segments for conifers *Abies concolor* (closed circles) and *Chamaecyparis lawsoniana* (open circles). Asterisked means are different. Mean ± SE for six stems.

parameter, c, was greater (steeper curve) by the spin technique (Table 1), but this did not translate into different P_{50} or mean cavitation values (Fig. 4 ‘Bo’). In *A. negundo*, the Weibull b parameter was 0.61 MPa less by the spin method (Table 1), resulting in P_{50} and mean cavitation values being 0.41 and 0.57 MPa less negative for spin vs. gravity methods (Fig. 4 ‘An’).

In *T. cordata*, the spin method gave slightly higher conductivities than the gravity method at the beginning of the vulnerability curve (Fig. 6a, upper right asterisked points). This difference was much more pronounced in preliminary experiments that were done on leafless trees outside of the

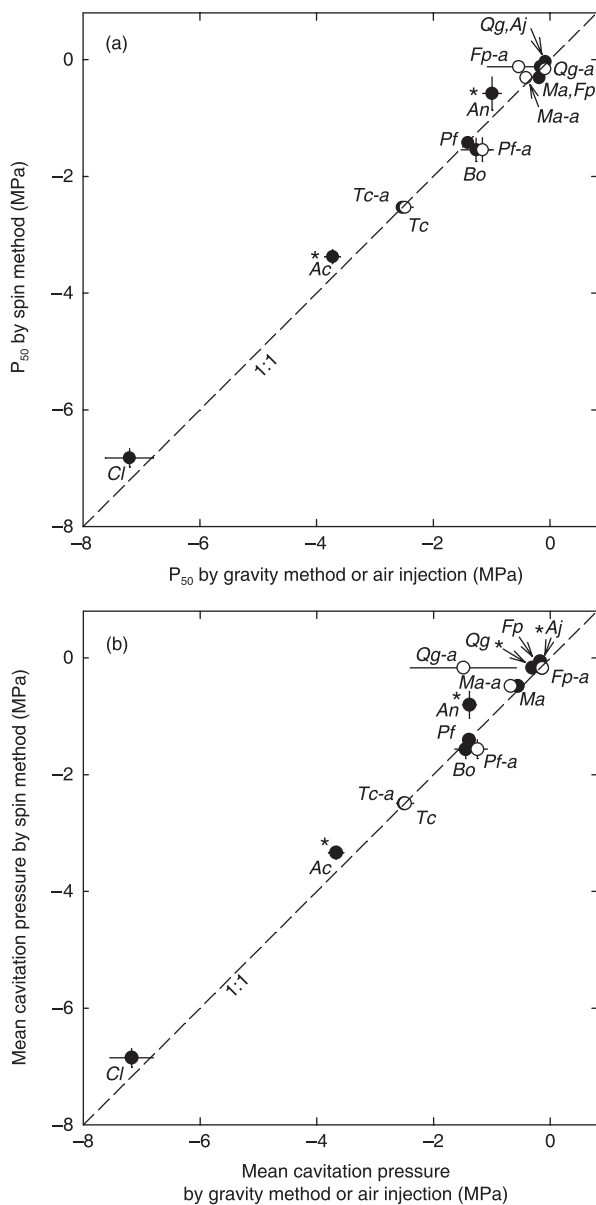

Fig. 4 (a) The 50% loss of conductivity pressure (P_{50}) from vulnerability curves measured by the spin method compared with the gravity method (closed symbols) and the air-injection method (open symbols). Species are identified by initials of species and genus, suffix '-a' indicates an air-injection data point. Asterisked means are different. Mean \pm SE for six stems. (b) Mean cavitation pressure compared for the same vulnerability curves as in (a). Ac, *Abies concolor*; Aj, *Albizia julibrissin*; An, *Acer negundo*; Bo, *Betula occidentalis*; Cl, *Chamaecyparis lawsoniana*; Fp, *Fraxinus pennsylvanica*; Ma, *Morus alba*; Pf, *Populus fremontii*; Qg, *Quercus gambelii*; Tc, *Tilia cordata*.

growing season (data not shown). The difference appeared to be the result of gas blockage during the gravity measurement because the conductivity rose to the higher spin value after flushing the stems. The spin value was also similar to the initial conductivity. We repeated the experiment twice during

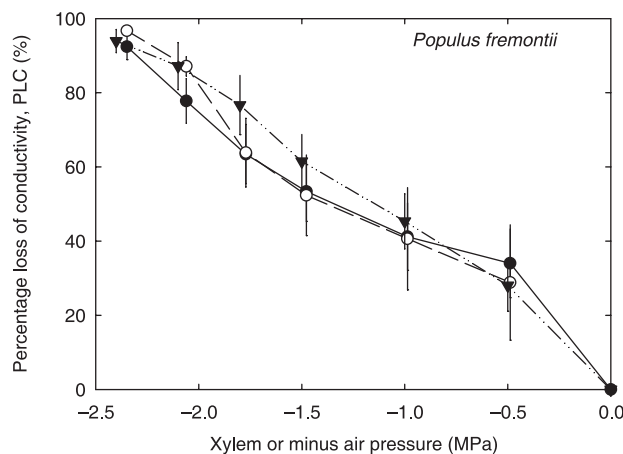

Fig. 5 Vulnerability curves for diffuse-porous *Populus fremontii* using the spinning (open circles) and gravity (closed circles) methods on the same stem segments, and the air-injection method (triangles) on separate segments. Conductivity is plotted as per cent loss from initial value (PLC) to facilitate comparison with the air-injection method used on separate stems. None of the means were different. Mean \pm SE for six stems.

the growing season but the original major discrepancy was not reproducible, so we did not investigate it further. The data shown (Figs 4 and 6) are for the final growing season measurement.

In *P. fremontii* and *T. cordata* (the final sampling), we also compared the spin method with the air-injection technique and found them to be very similar (e.g. Fig. 5, *P. fremontii*). Because different stems with potentially different initial conductivities were used, the comparison was based on PLC values rather than conductivity. Only three of 12 PLC measurements differed between the spin and air-injection method. The absolute value of these deviations averaged 12% (Fig. 6b). In both species, the Weibull slope parameter, c , was greater (steeper curve) by the spin method than the air-injection method (Table 1). However, this did not translate into significant differences in the P_{50} or mean cavitation values (Fig. 4, open symbols, Pf-a, Tc-a).

Ring-porous species

The spin and gravity methods also gave similar vulnerability curves for the four ring-porous species (e.g. Fig. 7, *F. pennsylvanica*). The ring-porous curves were remarkable in showing a precipitous loss of conductivity beginning at pressures as modest as -0.1 MPa (e.g. Fig. 7). Correspondingly, the P_{50} and mean cavitation values tend to be less negative than in the other wood types (Fig. 4).

Only six of 24 conductivity measurements in the ring-porous group differed between the spin and gravity techniques (Fig. 8a). The absolute value of these deviations averaged only 9% relative to the species' initial conductivity. In *Q. gambelii* and *F. pennsylvanica* the Weibull curves were no different

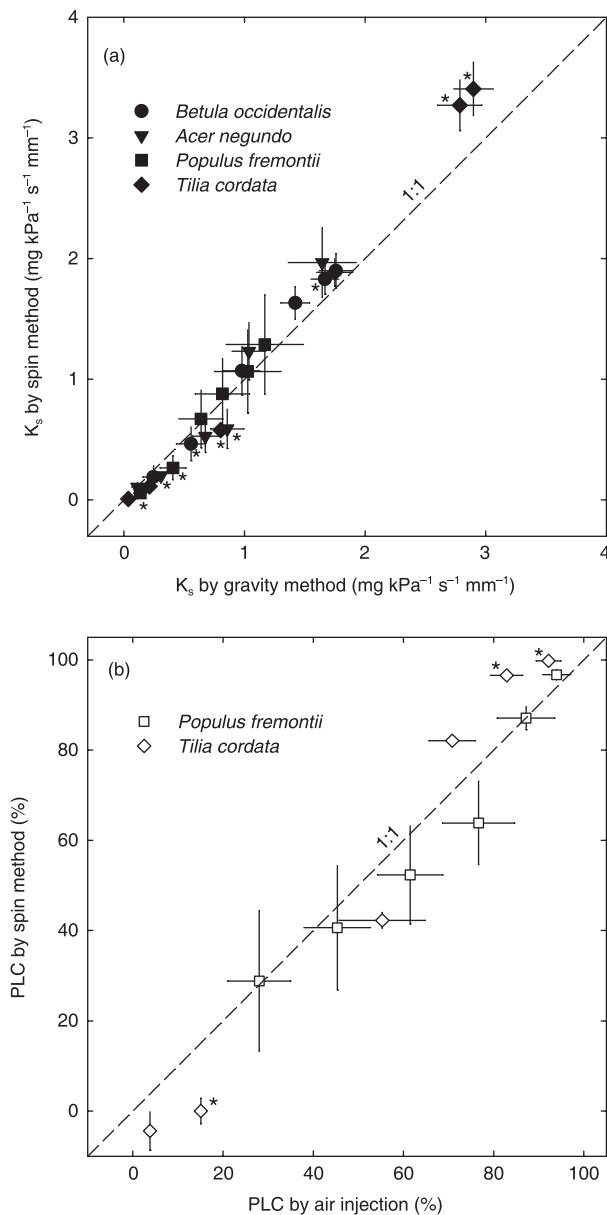

Fig. 6 (a) Hydraulic conductivity on a stem cross-sectional basis measured by the spinning and gravity methods on the same segments for four diffuse-porous species. Asterisked means are different. Mean \pm SE for six stems. (b) Hydraulic conductivity loss from initial value (PLC) measured by the spinning and air-injection methods on separate stem segments for two of the diffuse porous species in (a); PLC is used to facilitate comparison between separate stem segments. Asterisked means are different. Mean \pm SE for six stems.

between the gravity and spin methods (Table 1) and neither were the P_{50} values (Fig. 4a, closed symbols, Qg, Fp). The mean cavitation value was also not influenced by technique in *F. pensylvanica*, but it was 0.14 MPa less negative by the spin method for *Q. gambelii* (Fig. 4b, closed symbols, Qg, Fp).

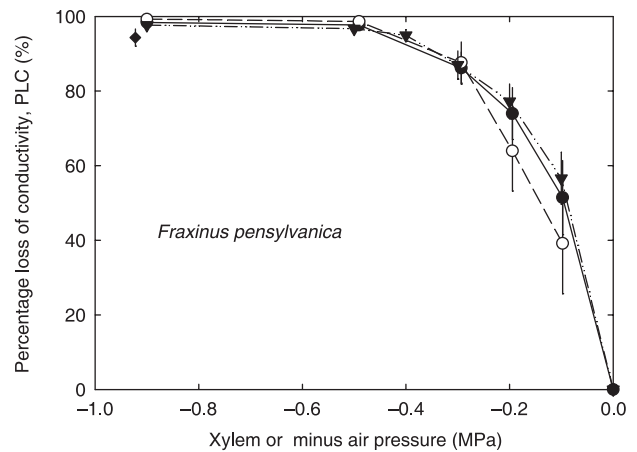

Fig. 7 Vulnerability curves for ring-porous *Fraxinus pensylvanica* using the spin (open circles) and gravity (closed circles) methods on the same stem segments, and the air-injection method (triangles) on separate segments. Conductivity is plotted as per cent loss from initial value (PLC) to facilitate comparison with the air-injection method used on separate stems. None of the means were different. Mean \pm SE for six stems. Native PLC measured on stem segments harvested at midday from the same plant is also shown (diamond). Mean \pm SE for five stems.

In *M. alba*, the Weibull slope parameter, c , was greater (steeper curve) by the spin method (Table 1), but this did not cause any difference in the P_{50} or mean cavitation values (Fig. 4, closed symbols, Ma). In *A. julibrissin* the Weibull b parameter was 0.09 MPa less by the spin method (Table 1) and the mean cavitation pressure was 0.11 MPa less negative (Fig. 4b, closed symbol, Aj). There was no difference in the P_{50} between methods for this species (Fig. 4a, closed symbol, Aj).

To test whether the precipitous loss in conductivity at modest xylem pressures in ring-porous species might have been an artifact of the spin method, the order of measurement was reversed. In the standard protocol, the conductivity was measured by the spin method before the gravity method. Nucleating agents in the test solution could flow into the negative pressure region at the stem center and artificially trigger cavitation, particularly if there were no vessel ends to filter them out. In an experiment with *Q. gambelii*, the stems were spun without inducing any pressure difference, and thus no flow, between the reservoirs. The stems were then measured with the gravity method before being put back in the centrifuge and measured at the same stem pressure as before by inducing flow and using the spin method. The two curves were not different (data not shown) and both showed the precipitous initial drop in conductivity seen in the standard protocol. This result suggests that cavitation was not induced by the flow of the test solution or any contaminants it might contain.

As a further check on the validity of the spin method for ring-porous species PLC values were compared with the air-injection technique. Full air-injection curves were done

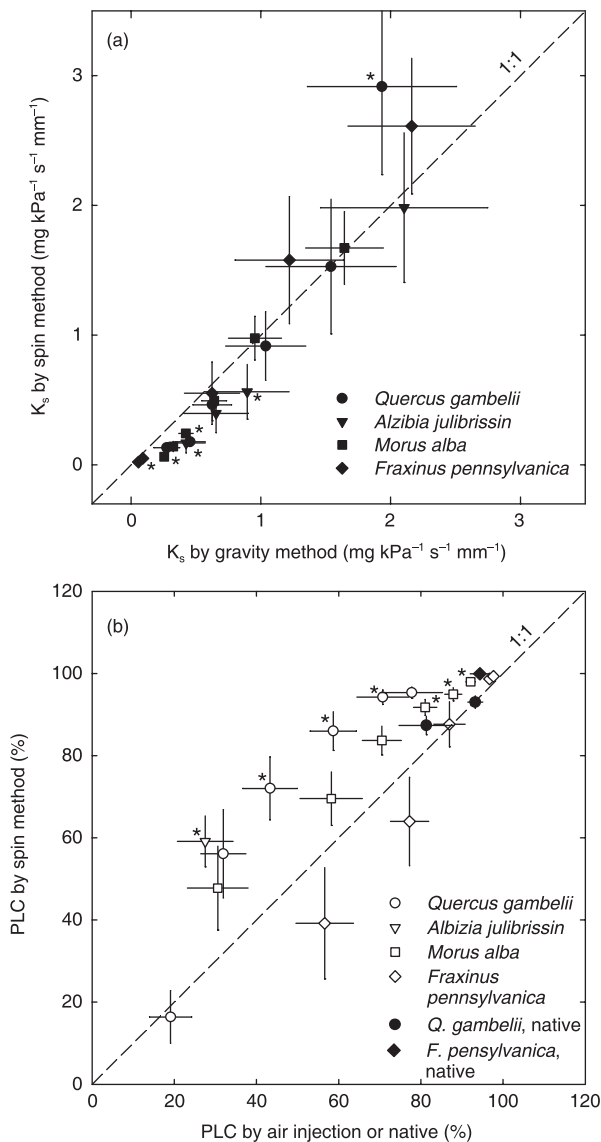

Fig. 8 (a) Hydraulic conductivity on a stem cross sectional basis measured by the spin and gravity methods on the same segments for four ring-porous species. Asterisked means are different. Mean \pm SE for six stems. (b) Hydraulic conductivity loss from initial value (PLC) measured by the spin and air-injection methods on separate stem segments for the ring porous species in panel a. The PLC is used to facilitate comparison between separate stem segments. Mean \pm SE for six stems. Native PLC data for *Fraxinus pennsylvanica* and *Quercus gambelii* is also shown relative to PLC calculated from a Weibull function fit to the centrifuge curve (closed symbols, mean \pm SE for five stems for native PLC).

for all but *A. julibrissin*, and they were similar to the centrifuge curves (Fig. 7, *F. pennsylvanica*). Seven of 18 PLC measurements differed between the spin and air-injection method. The absolute value of these deviations averaged 16% (Fig. 8b). The Weibull parameters were not different except in *F. pennsylvanica* where the slope parameter, c , was greater (steeper curve) by the spin method than the air-injection method (Table 1).

However, this did not translate into significant differences in the P_{50} or mean cavitation values (Fig. 4, open symbols, Fp-a, Qg-a, Ma-a).

To test whether the ring-porous vulnerability curve accurately predicted natural cavitation in the field, native embolism was measured on *F. pennsylvanica* and *Q. gambelii*. In *F. pennsylvanica*, native embolism at a midday stem pressure of $c. -0.9$ MPa was $c. 94\%$ and no different from that predicted by the spinning curve (Fig. 8b, closed diamond; see also Fig. 7). In *Q. gambelii*, the native embolism at a midday stem pressure of -0.80 ± 0.03 MPa was $81 \pm 7\%$, and at -1.04 ± 0.04 MPa it was $93 \pm 2\%$. Neither value was different from that predicted from the centrifuge curve (Fig. 8b, closed circles). The gravity method was used for the curve in this comparison, but gravity and spin curves were identical in this species (Table 1).

Discussion

In 10 species with very different xylem anatomies, the spin method generally gave a vulnerability curve similar to the gravity method. When the spin method differed, it tended to indicate higher conductivities (less cavitation) than the gravity method at the beginning of vulnerability curves, equal conductivities in the middle part of the curve, and lower conductivities at the end of the curve (Figs 3, 6a and 8a). The differences were small, generally in the order of 10%. When Weibull function parameters differed, the spin method tended to give smaller b -values (less cavitation resistance, 3 of 10 species) and greater c -values (a steeper curve slope, 2 of 10 species) than the gravity technique (Table 1). As a result, the P_{50} s were less negative by the spin method in two of 10 species, and the mean cavitation pressure was less negative in four of 10 species (Fig. 4). However, the differences in these six instances averaged only 0.32 MPa.

The occasional tendency for the spin method to indicate slightly less cavitation resistance than the gravity method may result from the fact that the conductivity measurements are made under negative rather than positive pressure. This would tend to increase the size of the gas volume inside the cavitated conduits by direct pressure–volume relationships and by inhibiting refilling by gas dissolution. This may result in the tendency for lower conductivities at the end of the vulnerability curve which produced the shift to less negative P_{50} and mean cavitation pressure. Because the difference was only occasional and small, it is unlikely that any conduits were completely refilled under the positive pressures used during the gravity measurement. Although it is theoretically possible that vessel diameters might constrict under the greater negative pressures towards the end of the curve and cause lower conductivity by the spin method, it is unlikely because we saw no evidence for conductivity increasing as pressures became less negative using the spin method.

The opposite tendency of the spin method to indicate less of a drop in conductivity at the beginning of the vulnerability

curve is difficult to explain. The effect was too subtle and variable to investigate. When it was observed, the conductivity at the start of the curve measured during spinning was generally similar to the initial K_i gravity measurement. Only the postspin gravity measurements were lower than K_i , and the effect was reversible by flushing. These observations suggest that the effect was not a result of pit membrane distortion caused by the typically higher pressure differences applied in the spin method, because it was the gravity measurement that deviated from K_i , not the spin measurement, and it is not obvious why flushing should eliminate the deviation.

In contrast to Cochard's observations with *Fraxinus excelsior* (Cochard *et al.*, 2005), we found no evidence that the spin method caused vulnerability curve artifacts in ring-porous species. The spin and gravity methods gave similar results in our material. The spin method also gave similar curves to the independent air-injection technique (Figs 4b, 7 and 8b), although in some species it overestimated the loss of conductivity compared with the air-injection method (Fig. 8b, asterisked open symbols). The general agreement of results argues against artifact, particularly since the air-injection method involves no negative pressure or centrifugation in any form. Perhaps most convincing is that our ring-porous centrifuge curves successfully predicted native embolism (Fig. 8b, closed symbols).

Cochard speculated that his variable results for ring-porous stems were caused by long vessels running completely through the segments, and he recommended that such material should not be used for vulnerability curves. The reason given was that impurities flowing through the vessels during the spin method would not be filtered by pit membranes and so could prematurely nucleate cavitation in open vessels. We found no evidence for this, because we obtained the same results whether the gravity method (in which there is no flow during centrifugation) preceded or followed the spin method. However, our material may have had fewer open vessels. Vessel length data on three of the species (*Q. gambelii*, *F. pennsylvanica* and *M. alba*) from a related project using the same-diameter stem segments (Hacke *et al.*, 2006) indicated that only 8–16% of the vessels were cut open at both ends in the 275-mm long segments used in this study compared with 50% estimated for Cochard's *F. excelsior*.

Even if there are a substantial number of open vessels, it is not clear why they should introduce artifacts in either the gravity or air-injection techniques. In neither method is there flow through the stem during the induction of cavitation. If the cavitation is caused by air-entry in the central region of the segment where the stress is applied, these sites would presumably be present whether or not the vessel is cut open at the segment ends that are far from the site of air-seeding. More study is required to determine how sensitive the methods are to the proportion of open vessels.

A more important reason for Cochard's variable results for *F. excelsior* may be that he measured PLC relative to an 'initial'

conductivity at -0.5 MPa. At this pressure our data indicate that most of the conductivity is already lost to cavitation in ring-porous xylem (e.g. Fig. 7, *F. pennsylvanica*). Variability would result simply from the use of a much lower reference conductivity for calculating the PLC.

Our results add to the evidence that ring porous xylem contains a substantial proportion of extremely vulnerable vessels. This was confirmed by over 80% native embolism measured at midday in *F. pennsylvanica* and *Q. gambelii* as predicted by their vulnerability curves (Figs 7 and 8b). Similar vulnerability curves have been observed for lianas and root xylem of some species (Sperry & Saliendra, 1994; Pockman & Sperry, 2000; Tibbetts & Ewers, 2000; Hacke *et al.*, 2006), material that also has large vessels. Some of the vulnerable xylem may be from previous years and be weakened from previous stress events or age (Hacke *et al.*, 2001b). However, the phenomenon has been observed even in current-year twigs (Hacke *et al.*, 2006). Importantly, high PLC in ring-porous trees does not necessarily mean that the conductivity is lower than in nonembolized diffuse-porous trees because ring-porous xylem has much greater initial conductivity (Hacke *et al.*, 2006). Nevertheless, our strange observation that ring-porous species appear to operate with only a fraction of their potential conducting capacity at midday requires further investigation.

Of the two centrifuge protocols, the spin method is arguably the most accurate because the xylem sap is under negative pressure during the conductivity measurement which eliminates any possibility of refilling artifacts (Cochard, 2002). However, the general similarity between the spinning and gravity methods indicates that refilling is not a major problem. This inspires confidence in the large quantity of published data using the gravity technique. At present we cannot explain the occasional tendency for the gravity method to show more of a drop in conductivity at the beginning of the vulnerability curve than the spin method.

The spin method did have disadvantages, some of which could be minimized with further improvements. Conductivity cannot be measured without inducing negative pressure which prevents the measurement of the true maximum (initial) conductivity, K_i . Material with low conductance was also impossible to measure because it took too long for the meniscus to move even in the reservoir with the smallest surface area. The problem could be minimized with a rotor designed for shorter segments that would therefore have higher conductance. Reservoirs with a greater difference in water level (5 mm was our maximum; Fig. 1) would also help by increasing the pressure difference driving flow. The meniscus was also difficult to visualize at times and looking through the microscope was tedious except at high speeds, when it was intimidating. All of these difficulties could be resolved with the appropriate video camera arrangement. The accuracy and speed of the technique suggests it will be widely adopted in future cavitation studies.

Acknowledgements

Supported in part by National Science Foundation grant NSF-IBN-0416297 to J.S.S and National Science Foundation of China grant 30230290–2 to Y.L. We thank Elzard Sikkema, undergraduate assistant from the University of Utah, for assistance in setting up the centrifugation apparatus. Hervé Cochard of INRA in Clermont-Ferrand, France gave much helpful advice.

References

- Alder NN, Pockman WT, Sperry JS, Nuismer S. 1997. Use of centrifugal force in the study of xylem cavitation. *Journal of Experimental Botany* 48: 665–674.
- Canny MJ. 1998. Applications of the compensating pressure theory of water transport. *American Journal of Botany* 85: 897–909.
- Cochard H. 2002. A technique for measuring xylem hydraulic conductance under high negative pressures. *Plant, Cell & Environment* 25: 815–819.
- Cochard H, Cruiziat P, Tyree MT. 1992. Use of positive pressures to establish vulnerability curves: Further support for the air-seeding hypothesis and implications for pressure–volume analysis. *Plant Physiology* 100: 205–209.
- Cochard H, Gaele D, Bodet C, Tharwat I, Poirier M, Ameglio T. 2005. Evaluation of a new centrifuge technique for rapid generation of xylem vulnerability curves. *Physiologia Plantarum* 124: 410–418.
- Davis SD, Ewers FW, Portwood KA, Sperry JS, Crocker MC, Adams GC. 2002. Shoot dieback during prolonged drought in *Ceanothus* chaparral in California: a possible case of hydraulic failure. *American Journal of Botany* 89: 820–828.
- Hacke UG, Sperry JS, Pockman WP, Davis SD, McCulloh KA. 2001a. Trends in wood density and structure are linked to prevention of xylem implosion by negative pressure. *Oecologia* 126: 457–461.
- Hacke UG, Sperry JS, Wheeler JK, Castro L. 2006. Scaling of angiosperm xylem structure with safety and efficiency. *Tree Physiology* 26: 689–701.
- Hacke UG, Stiller V, Sperry JS, Pittermann J, McCulloh KA. 2001b. Cavitation fatigue. Embolism and refilling cycles can weaken the cavitation resistance of xylem. *Plant Physiology* 125: 779–786.
- Linton MJ, Sperry JS, Williams DG. 1998. Limits to water transport in *Juniperus osteosperma* and *Pinus edulis*: implications for drought tolerance and regulation of transpiration. *Functional Ecology* 12: 906–911.
- Maherali H, Pockman WT, Jackson RB. 2003. Adaptive variation in the vulnerability of woody plants to xylem cavitation. *Ecology* 85: 2184–2199.
- McElrone AJ, Pockman WT, Martinez-Vilalta J, Jackson RB. 2004. Variation in xylem structure and function in stems and roots of trees to 20 m depth. *New Phytologist* 163: 507–517.
- Neufeld HS, Grantz DA, Meinzer FC, Goldstein G, Crisosto GM, Crisosto C. 1992. Genotypic variability in vulnerability of leaf xylem to cavitation in water-stressed and well-irrigated sugarcane. *Plant Physiology* 100: 1020–1028.
- Pittermann J, Sperry JS, Wheeler JK, Hacke UG, Sikkema EH. 2006. Mechanical reinforcement of tracheids compromises the hydraulic efficiency of conifer xylem. *Plant, Cell & Environment* 29: 1618–1628.
- Pockman WT, Sperry JS. 2000. Vulnerability to cavitation and the distribution of Sonoran desert vegetation. *American Journal of Botany* 87: 1287–1299.
- Pockman WT, Sperry JS, O'Leary JW. 1995. Sustained and significant negative water pressure in xylem. *Nature* 378: 715–716.
- Salleo S, Hinchley TM, Kikuta SB, Lo Gullo MA, Weilgony P, Yoon TM, Richter H. 1992. A method for inducing xylem emboli in situ: Experiments with a field-grown tree. *Plant, Cell & Environment* 15: 491–497.
- Sperry JS. 1986. Relationship of xylem embolism to xylem pressure potential, stomatal closure, and shoot morphology in the palm *Rhapis excelsa*. *Plant Physiology* 80: 110–116.
- Sperry JS, Saliendra NZ. 1994. Intra- and inter-plant variation in xylem cavitation in *Betula occidentalis*. *Plant, Cell & Environment* 17: 1233–1241.
- Sperry JS, Tyree MT. 1990. Water-stress-induced xylem embolism in three species of conifers. *Plant, Cell & Environment* 13: 427–436.
- Sperry JS, Adler FR, Campbell GS, Comstock JP. 1998. Limitation of plant water use by rhizosphere and xylem conductance: results from a model. *Plant, Cell & Environment* 21: 347–359.
- Sperry JS, Nichols KL, Sullivan JEM, Eastlack SE. 1994. Xylem embolism in ring-porous, diffuse-porous, and coniferous trees of northern Utah and interior Alaska. *Ecology* 75: 1736–1752.
- Sperry JS, Saliendra NZ, Pockman WT, Cochard H, Cruiziat P, Davis SD, Ewers FW, Tyree MT. 1996. New evidence for large negative xylem pressures and their measurement by the pressure chamber method. *Plant, Cell & Environment* 19: 427–436.
- Tibbetts TJ, Ewers FW. 2000. Root pressure and specific conductivity in temperate lianas: exotic *Celastrus orbiculatus* (Celastraceae) vs native *Vitis riparia* (Vitaceae). *American Journal of Botany* 87: 1272–1278.
- Tyree MT, Sperry JS. 1989. Vulnerability of xylem to cavitation and embolism. *Annual Review of Plant Physiology and Molecular Biology* 40: 19–38.
- Willson C, Jackson RB. 2006. Xylem cavitation caused by drought and freezing stress in four co-occurring *Juniperus* species. *Physiologia Plantarum* 127: 374–382.
- Zimmermann MH. 1983. *Xylem structure and the ascent of sap: Springer series in wood science*. Berlin, Germany: Springer-Verlag.